

panels

THE INFORMATION LISTED BELOW PROVIDES YOU WITH BASIC FEATURES OF COMPILE PANELS:

- Compile Panels are:
 - Available in three (3) heights: 42", 54" and 66"; and seven (7) widths: 24", 30", 36", 42", 48" and 60".
 - 2 3/8" thick.
 - Monolithic
- Compile monolithic panels are not tackable.
- Raceway openings are 1.375" x 2.680".
- Panels 24" wide include raceway covers with 2 knockouts.
- Panels 30" – 60" wide include raceway covers with 3 knockouts.
- Opposite sides of each Module may have a different fabric within the same grade at no upcharge.
- If different grades of fabric are used on one panel, the entire panel must be priced at the highest grade.
- Standard with aluminum frame.
- Individual fabric covered modules incorporated into an aluminum frame.
- Reinforced aluminum raceway covers are included when ordering panel packages or may be ordered and shipped separately. Raceway covers can be replaced in the field to change a panel from non-powered to powered (or vice versa).
- Base raceway lifts up and locks in an upright 90-degree position, or can be removed for open access to base raceway.
- Electric knockouts in the raceway have color matched plastic covers that snap into place from the outside of the cover, when a duplex is not required. Electric knockout covers must be specified separately.
- 3 panel connector brackets per side for 42"h and 54"h come installed on panels and universal posts.
- 4 panel connector brackets per side for 66"h panels come installed on panels and universal posts.
- Panel connector brackets are opposite direction of each other per panel side, and can be removed with one screw per bracket.



MONOLITHIC PANEL PACKAGES - PAGES 16 & 17, 22-25

Non-Powered Compile Monolithic Fabric Panel Package

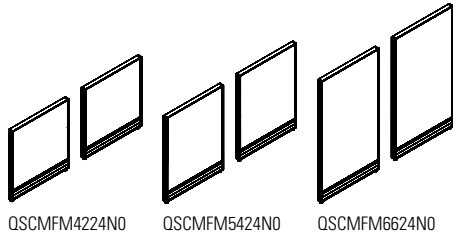

Powered Compile Monolithic Fabric Panel Package

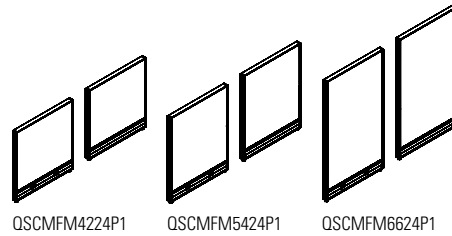

Non-Powered Compile Monolithic Fabric Panel Package

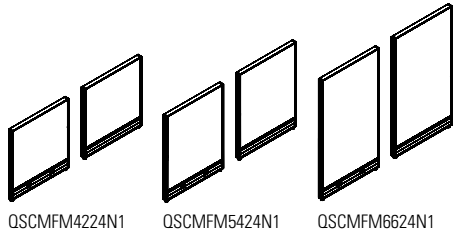

Powered Compile Monolithic Fabric Panel Package

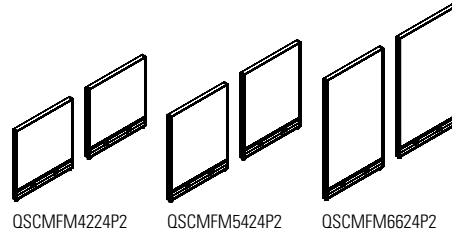

Non-Powered Compile Monolithic Fabric Panel Package

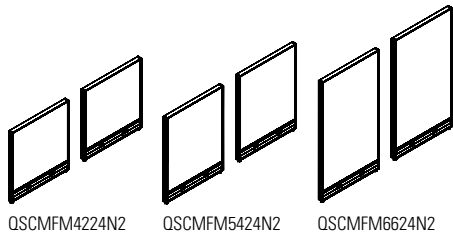

Model Definitions:

- N0 = No punch outs on raceways.
- N1 = Raceway punch out on one side.
- N2 = Raceway punch out on both sides.
- P1 = Power harness and raceway punch out on one side.
- P2 = Power harness and raceway punch outs on two sides.

RACEWAY COVER OPTIONS (Suffix)

- (N0) No Knockouts Side 1 and Side 2
- (N1) Knockouts Side 1 – No Knockout Side 2
- (N2) Knockouts Side 1 and Side 2
- (P1) Knockouts Side 1 – No Knockout Side 2
- (P2) Knockouts Side 1 and Side 2

PRIVACY GLASS / FELT / OVER PANELS

Fabric Over Panel

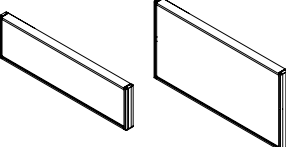

QSCMOF1224 QSCMOF2424

Compile Glazed Over Panels

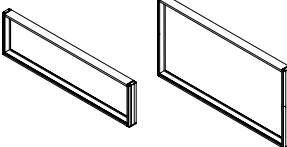

QSCMOG1224 QSCMOG2424

Privacy Glass Panel Width



QSCMPSEF1224

Embedded Felt Divider Over Panel

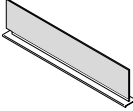

QSCMPSEF1224



This page provides an exploded view of a sample Panel Package highlighting each **Panel** component included within the package.

Package Components

Package 1 CMFM6636N0

- A. (1) 66" h x 36" w Monolithic Fabric Panel
- B. (2) 36" w Raceway Covers Without Knockouts

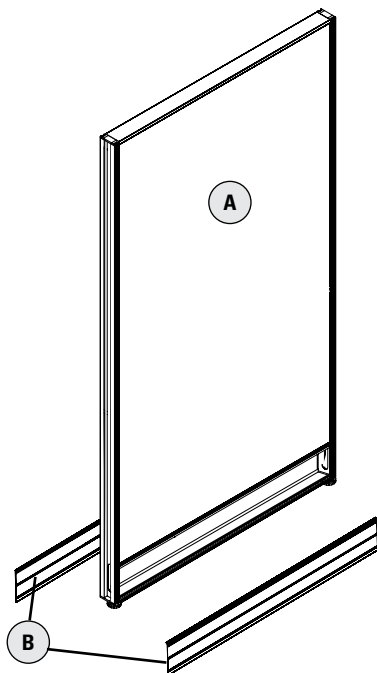

Package 2 CMFM6636P2

- C. (1) 66" h x 36" w Single Segmented Fabric Panel
- D. (2) 36" w Raceway Covers With Knockouts
- E. (1) 36" w Power Distribution Housing

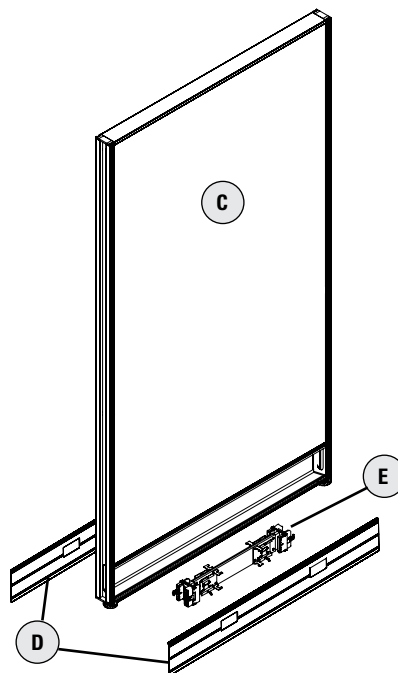

Package 3 CHP66-2

- F. (1) 66" h Universal Corner Post
- G. (2) Trim Inserts for 66" Universal Corner Post
- H. (1) Post Base Cover for 2-Way Application
- I. "Quick Connect" comes standard with Panels and Universal Corner Post

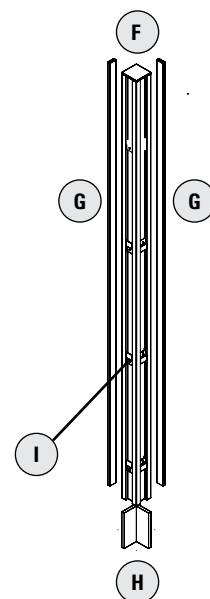

CMFMXXYYN - NON-POWERED COMPILE FABRIC MONOLITHIC PANEL PACKAGE

- Non powered.
- Includes one panel and two raceway covers with no punchouts.
- Individual fabric-covered modules incorporated into an aluminum frame.
- Opposite sides of each module may have a different fabric within the same grade at no upcharge.
- If different grades of fabric are used on one panel, the entire panel must be priced at highest grade.
- Panels are not tackable or acoustical.
- Note: Trim is not required at a straight connection between two panels of the same height.
- 3 Panel connector brackets per side come standard with 42”h, 48”h and 54”h panels.
- 4 Panel connector brackets per side come standard with 66”h panels.
- Panels contain leveling glides. Maximum extension of glides is 2”.

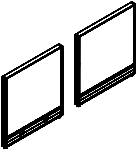
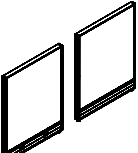
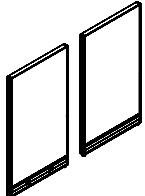
	DESCRIPTION	PRODUCT CODE	LIST PRICE	DIMENSIONS/INCHES		
				H	W	D
	Non-Powered Compile Fabric Monolithic Panel Package - 42"	QSCMFM4224N_	365	42	24	2 3/8
		QSCMFM4230N_	412	42	30	2 3/8
		QSCMFM4236N_	447	42	36	2 3/8
		QSCMFM4242N_	494	42	42	2 3/8
		QSCMFM4248N_	525	42	48	2 3/8
		QSCMFM4260N_	613	42	60	2 3/8
	Non-Powered Compile Fabric Monolithic Panel Package - 54"	QSCMFM5424N_	381	54	24	2 3/8
		QSCMFM5430N_	431	54	30	2 3/8
		QSCMFM5436N_	480	54	36	2 3/8
		QSCMFM5442N_	533	54	42	2 3/8
		QSCMFM5448N_	561	54	48	2 3/8
		QSCMFM5460N_	663	54	60	2 3/8
	Non-Powered Compile Fabric Monolithic Panel Package - 66"	QSCMFM6624N_	426	66	24	2 3/8
		QSCMFM6630N_	489	66	30	2 3/8
		QSCMFM6636N_	558	66	36	2 3/8
		QSCMFM6642N_	627	66	42	2 3/8
		QSCMFM6648N_	678	66	48	2 3/8
		QSCMFM6660N_	829	66	60	2 3/8

Raceway Cover Options (1) Shown

- **RACEWAY COVER OPTIONS (Suffix)**
 - (0) No Knockouts Side 1 and Side 2
 - (1) Knockouts Side 1 – No Knockout Side 2
 - (2) Knockouts Side 1 and Side 2



CMFMXXYP - POWERED COMPILE FABRIC MONOLITHIC PANEL PACKAGE

- With power distribution harness.
- Includes one panel, power harness, one raceway cover with punchout and one raceway cover with no punchout.
- Individual fabric-covered modules incorporated into an aluminum frame.
- Opposite sides of each module may have a different fabric within the same grade at no upcharge.
- If different grades of fabric are used on one panel, the entire panel must be priced at highest grade.
- Panels are not tackable or acoustical.
- Note: Trim is not required at a straight connection between two panels of the same height.
- 3 Panel connector brackets per side come standard with 42”h, 48”h and 54”h panels.
- 4 Panel connector brackets per side come standard with 66”h panels.
- Panels contain leveling glides. Maximum extension of glides is 2”.

	DESCRIPTION	PRODUCT CODE	LIST PRICE	DIMENSIONS/INCHES		
				H	W	D
	Powered Compile Fabric Monolithic Panel Package - 42”	QSCMFM4224P_	519	42	24	2 3/8
		QSCMFM4230P_	619	42	30	2 3/8
		QSCMFM4236P_	665	42	36	2 3/8
		QSCMFM4242P_	715	42	42	2 3/8
		QSCMFM4248P_	764	42	48	2 3/8
		QSCMFM4260P_	854	42	60	2 3/8
	Powered Compile Fabric Monolithic Panel Package - 54”	QSCMFM5424P_	533	54	24	2 3/8
		QSCMFM5430P_	635	54	30	2 3/8
		QSCMFM5436P_	696	54	36	2 3/8
		QSCMFM5442P_	754	54	42	2 3/8
		QSCMFM5448P_	801	54	48	2 3/8
		QSCMFM5460P_	902	54	60	2 3/8
	Powered Compile Fabric Monolithic Panel Package - 66”	QSCMFM6624P_	578	66	24	2 3/8
		QSCMFM6630P_	696	66	30	2 3/8
		QSCMFM6636P_	775	66	36	2 3/8
		QSCMFM6642P_	847	66	42	2 3/8
		QSCMFM6648P_	918	66	48	2 3/8
		QSCMFM6660P_	1069	66	60	2 3/8

Raceway Cover Options (1) Shown

- **RACEWAY COVER OPTIONS (Suffix)**
 - (1) Knockouts Side 1 – No Knockout Side 2
 - (2) Knockouts Side 1 and Side 2

CMOF - COMPILE FABRIC OVER PANEL

- Fabric-covered modules incorporated into an aluminum frame.
- Opposite sides of each module may have a different fabric within the same grade at no upcharge.
- If different grades of fabric are used on one panel, the entire panel must be priced at highest grade.
- One CSHD Slider Kit for Over Panel included
- Note: Trim is not required at a straight connection between two panels of the same height.
- Maximum stacking one high. Not load bearing.

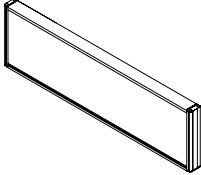
DESCRIPTION	PRODUCT CODE	LIST PRICE	DIMENSIONS/INCHES		
			H	W	D
 <p>Compile Fabric Over Panel</p>	QSCMOF1224	205	12	24	2.3
	QSCMOF1230	240	12	30	2.3
	QSCMOF1236	267	12	36	2.3
	QSCMOF1242	302	12	42	2.3
	QSCMOF1248	349	12	48	2.3
	QSCMOF1260	429	12	60	2.3
	QSCMOF2424	308	24	24	2.3
	QSCMOF2430	356	24	30	2.3
	QSCMOF2436	398	24	36	2.3
	QSCMOF2442	446	24	42	2.3
	QSCMOF2448	481	24	48	2.3
	QSCMOF2460	614	24	60	2.3

CMOG - COMPILE GLAZED OVER PANEL

- Glazed module incorporated into an aluminum frame.
- One CSHD Slider Kit for Over Panel included
- Available in clear (CLR) glass.
- Note: Trim is not required at a straight connection between two panels of the same height.
- Maximum stacking one high. Not load bearing.

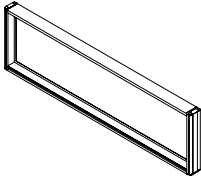
DESCRIPTION	PRODUCT CODE	LIST PRICE	DIMENSIONS/INCHES		
			H	W	D
 <p>Compile Glazed Over Panel</p>	QSCMOG1224	183	12	24	2.3
	QSCMOG1230	213	12	30	2.3
	QSCMOG1236	238	12	36	2.3
	QSCMOG1242	266	12	42	2.3
	QSCMOG1248	305	12	48	2.3
	QSCMOG1260	380	12	60	2.3
	QSCMOG2424	272	24	24	2.3
	QSCMOG2430	294	24	30	2.3
	QSCMOG2436	346	24	36	2.3
	QSCMOG2442	388	24	42	2.3
	QSCMOG2448	414	24	48	2.3
	QSCMOG2460	531	24	60	2.3



CMPEGXX - COMPILE PRIVACY GLASS PANEL WIDTH

- Attaches on top of Compile Panels to add privacy or divide space.
- Available in clear (CLR) glass.
- Width dimensions given are width of glass only.
- Attachment hardware is provided for attaching to panels.

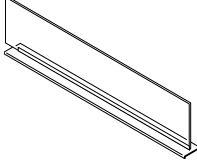
DESCRIPTION	PRODUCT CODE	LIST PRICE	DIMENSIONS/INCHES		
			H	W	D
 <p>Compile Privacy Glass</p>	QSCMPSEG1224	264	12	24	2.41
	QSCMPSEG1230	288	12	30	2.41
	QSCMPSEG1236	306	12	36	2.41
	QSCMPSEG1242	319	12	42	2.41
	QSCMPSEG1248	339	12	48	2.41
	QSCMPSEG1260	360	12	60	2.41

CMPEF - EMBEDDED FELT DIVIDER OVER PANEL

- Privacy felt panel integrated with aluminum top trim.
- Attaches on top of panels to add privacy or divide space.
- Includes aluminum trim with channel and felt tile.
- Felt and attachment hardware to ship separately
- 9mm Felt material is tackable and comes in 3 different colors. Please specify color.

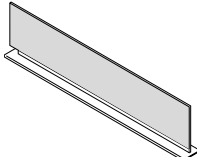
DESCRIPTION	PRODUCT CODE	LIST PRICE	DIMENSIONS/INCHES		
			H	W	D
 <p>12" Integrated Felt Divider, Panel Width</p>	QSCMPSEF1224	107	12	24	2.41
	QSCMPSEF1230	124	12	30	2.41
	QSCMPSEF1236	148	12	36	2.41
	QSCMPSEF1242	163	12	42	2.41
	QSCMPSEF1248	244	12	48	2.41
	QSCMPSEF1260	285	12	60	2.41

CMLEPXXXNC - END OF RUN GALLERY PANEL WITH NO END CONNECTION

- Provides floor standing support while enclosing the end of a panel run.
- Attached at the end of a straight panel run with connectors to form a T configuration.
- No connections at both ends, connection is at the center interior face.
- Includes all attachment hardware and glides.
- Total height is inclusive of panel glides extended to their full height.
- 51" wide gallery panel accommodates two 24" deep surface while the 63" wide accommodates two 30" deep surfaces.
- Please specify LP laminate finish and PVC edge finish.
- If a wood grain laminate is chosen, grain direction run horizontally.
- Gallery panel is edged in PVC on exposed edges and self edged on bottom.

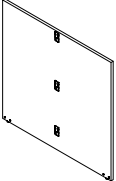
DESCRIPTION	PRODUCT CODE	LIST PRICE	DIMENSIONS/INCHES		
			H	W	D
 End of Run Gallery Panel	QSCMLEP4251NC	789	42	50.30	1
	QSCMLEP4263NC	917	42	62.30	1
	QSCMLEP4851NC	867	48	50.30	1
	QSCMLEP4863NC	1007	48	62.30	1
	QSCMLEP5451NC	945	54	50.30	1
	QSCMLEP5463NC	1099	54	62.30	1

CMLMPXXXNC - MIDDLE OF RUN GALLERY PANEL WITH NO END CONNECTION

- Provides floor standing support in the middle of a panel run.
- Attached in the middle of a straight panel run with connectors to form an X configuration.
- No connections at both ends, connection is at center on both faces.
- Includes all attachment hardware and glides.
- Total height is inclusive of panel glides extended to their full height.
- 51" wide gallery panel accommodates two 24" deep surface while the 63" wide accommodates two 30" deep surfaces.
- Please specify LP laminate finish and PVC edge finish.
- If a wood grain laminate is chosen, grain direction run horizontally.
- Gallery panel is edged in PVC on exposed edges and self edged on bottom.

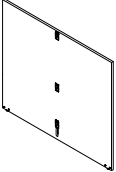
DESCRIPTION	PRODUCT CODE	LIST PRICE	DIMENSIONS/INCHES		
			H	W	D
 Middle of Run Gallery Panel	QSCMLMP4251NC	918	42	50.30	1
	QSCMLMP4263NC	1044	42	62.30	1
	QSCMLMP4851NC	996	48	50.30	1
	QSCMLMP4863NC	1136	48	62.30	1
	QSCMLMP5451NC	1074	54	50.30	1
	QSCMLMP5463NC	1228	54	62.30	1

CMLSEPLXXXNC - SINGLE END OF RUN GALLERY PANEL WITH NO END CONNECTION

- Provides floor standing support while enclosing the end of a panel run.
- Attached at the end of a straight panel run with connectors to form an L configuration.
- No connections at both ends, connection is at center on both faces.
- Includes all attachment hardware and glides.
- Total height is inclusive of panel glides extended to their full height.
- 27" wide gallery panel accommodate two 24" deep surface while the 33" wide accommodates two 30" deep surfaces.
- Please specify LP laminate finish and PVC edge finish.
- If a wood grain laminate is chosen, grain direction run horizontally.
- Gallery panel is edged in PVC on exposed edges and self edged on bottom.

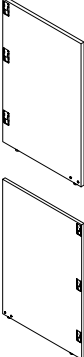
DESCRIPTION	PRODUCT CODE	LIST PRICE	DIMENSIONS/INCHES		
			H	W	D
 Single End of Run Gallery Panel	QSCMLSEPL4227NC	601	42	26.30	1
	QSCMLSEPR4227NC	601	42	26.30	1
	QSCMLSEPL4827NC	657	48	26.30	1
	QSCMLSEPR4827NC	657	48	26.30	1
	QSCMLSEPL5427NC	713	54	26.30	1
	QSCMLSEPR5427NC	713	54	26.30	1
	QSCMLSEPL4233NC	620	42	32.33	1
	QSCMLSEPR4233NC	620	42	32.33	1
	QSCMLSEPL4833NC	677	48	32.33	1
	QSCMLSEPR4833NC	677	48	32.33	1
	QSCMLSEPL5433NC	734	54	32.33	1
	QSCMLSEPR5433NC	734	54	32.33	1



CMLSMPXXXXNC - SINGLE MIDDLE OF RUN GALLERY PANEL WITH NO END CONNECTION

- Provides floor standing support at the middle of a panel run.
- Attached in the middle of a straight panel run with connectors to form a T configuration.
- No connections at the exposed end, connection is at both the interior and exterior face near the opposite end.
- Includes all attachment hardware and glides.
- Total height is inclusive of panel glides extended to their full height.
- 27" wide gallery panel accommodates a 24" deep surface while the 33" wide accommodates a 30" deep surface.
- Please specify LP laminate finish and PVC edge finish.
- If a wood grain laminate is chosen, grain direction run horizontally.
- Gallery panel is edged in PVC on exposed edges and self edged on bottom.

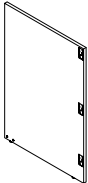
	DESCRIPTION	PRODUCT CODE	LIST PRICE	DIMENSIONS/INCHES		
				H	W	D
	Single Middle of Run Gallery Panel	QSCMLSMP4227NC	730	42	26.30	1
		QSCMLSMP4827NC	786	48	26.30	1
		QSCMLSMP5427NC	842	54	26.30	1
		QSCMLSMP4233NC	752	42	32.30	1
		QSCMLSMP4833NC	808	48	32.30	1
		QSCMLSMP5433NC	866	54	32.30	1

CMLPXXXX - END OF RUN GALLERY PANEL WITH END CONNECTIONS

- Provides floor standing support while enclosing the end of a panel run.
- Attached at the end of a straight panel run with connectors to form a T configuration.
- Connections at both ends as well as the center on the interior face.
- Includes all attachment hardware and glides.
- Total height is inclusive of panel glides extended to their full height.
- 51" wide gallery panel accommodates two 24" deep surface while the 63" wide accommodates two 30" deep surfaces.
- Please specify LP laminate finish and PVC edge finish.
- If a wood grain laminate is chosen, grain direction run horizontally.
- Gallery panel is edged in PVC on exposed edges and self edged on edge connecting to panel and bottom edge.

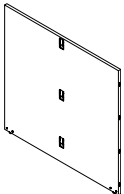
	DESCRIPTION	PRODUCT CODE	LIST PRICE	DIMENSIONS/INCHES		
				H	W	D
	End of Run Gallery Panel	QSCMLEP4251	821	42	50.30	1
		QSCMLEP4263	946	42	62.30	1
		QSCMLEP4851	898	48	50.30	1
		QSCMLEP4863	1038	48	62.30	1
		QSCMLEP5451	976	54	50.30	1
		QSCMLEP5463	1130	54	62.30	1

CMLMPXXXX - MIDDLE OF RUN GALLERY PANEL WITH END CONNECTIONS

- Provides floor standing support in the middle of a panel run.
- Attached in the middle of a straight panel run with connectors to form an X configuration.
- Connections at both ends as well as the center on the interior face.
- Includes all attachment hardware and glides.
- Total height is inclusive of panel glides extended to their full height.
- 51" wide gallery panel accommodates two 24" deep surface while the 63" wide accommodates two 30" deep surfaces.
- Please specify LP laminate finish and PVC edge finish.
- If a wood grain laminate is chosen, grain direction run horizontally.
- Gallery panel is edged in PVC on exposed edges and self edged on edge connecting to panel and bottom edge.

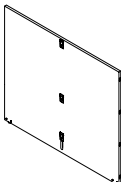
	DESCRIPTION	PRODUCT CODE	LIST PRICE	DIMENSIONS/INCHES		
				H	W	D
	Middle of Run Gallery Panel	QSCMLMP4251	923	42	50.30	1
		QSCMLMP4263	1049	42	62.30	1
		QSCMLMP4851	1001	48	50.30	1
		QSCMLMP4863	1141	48	62.30	1
		QSCMLMP5451	1078	54	50.30	1
		QSCMLMP5463	1235	54	62.30	1

CMLSEPLXXXX - SINGLE END PANEL WITH END CONNECTIONS

- Provides floor standing support while enclosing the end of a panel run.
- Attached at the end of a straight panel run with connectors to form an L configuration.
- Connections are at the exposed end on one side and near the end on the other interior face.
- Total height is inclusive of panel glides extended to their full height.

- 27" wide gallery panel accommodates a 24" deep surface while the 33" wide accommodates a 30" deep surface.
- Please specify LP laminate finish and PVC edge finish.
- If a wood grain laminate is chosen, grain direction run horizontally.
- Gallery panel is edged in PVC on exposed edges and self edged on edge connecting to panel and bottom edge.

	DESCRIPTION	PRODUCT CODE	LIST PRICE	DIMENSIONS/INCHES			
				H	W	D	
	Single End of Run Gallery Panel	QSCMLSEPL4227	615	42	26.30	1	
		QSCMLSEPR4227	615	42	26.30	1	
		QSCMLSEPL4827	673	48	26.30	1	
		QSCMLSEPR4827	673	48	26.30	1	
		QSCMLSEPL5427	728	54	26.30	1	
		QSCMLSEPR5427	728	54	26.30	1	
			QSCMLSEPL4233	635	42	32.33	1
			QSCMLSEPR4233	635	42	32.33	1
			QSCMLSEPL4833	691	48	32.33	1
			QSCMLSEPR4833	691	48	32.33	1
QSCMLSEPL5433			750	54	32.33	1	
QSCMLSEPR5433			750	54	32.33	1	

CMLSMPXXXX - SINGLE MIDDLE OF RUN GALLERY PANEL WITH END CONNECTIONS

- Provides floor standing support at the middle of a panel run.
- Attached in the middle of a straight panel run with connectors to form a T configuration
- Connections are at the exposed end and at the interior and exterior near the opposite end.
- Includes all attachment hardware and glides.
- Total height is inclusive of panel glides extended to their full height.

- 27" wide gallery panel accommodates a 24" deep surface while the 33" wide accommodates a 30" deep surface.
- Please specify LP laminate finish and PVC edge finish.
- If a wood grain laminate is chosen, grain direction run horizontally.
- Gallery panel is edged in PVC on exposed edges and self edged on edge connecting to panel and bottom edge.

	DESCRIPTION	PRODUCT CODE	LIST PRICE	DIMENSIONS/INCHES		
				H	W	D
	Single Middle of Run Gallery Panel	QSCMLSMP4227	744	42	26.30	1
		QSCMLSMP4827	801	48	26.30	1
		QSCMLSMP5427	855	54	26.30	1
		QSCMLSMP4233	767	42	32.30	1
		QSCMLSMP4833	824	48	32.30	1
		QSCMLSMP5433	882	54	32.30	1



CMLXPLXXXNC - EXTENSION END OF RUN, LEFT, NO CONNECTION

- Provides floor standing support while enclosing the end of a gallery panel run.
- Attached at the end of a gallery panel to extend the gallery panel run.
- Connections only at one exposed end.
- Includes all attachment hardware and glides.
- Total height is inclusive of panel glides extended to their full height.
- Please specify LP laminate finish and PVC edge finish.
- If a wood grain laminate is chosen, grain direction run horizontally.
- Gallery panel is edged in PVC on exposed edges and self edged on edge connecting to panel.

DESCRIPTION	PRODUCT CODE	LIST PRICE	DIMENSIONS/INCHES		
			H	W	D
 Extension End of Run Gallery Panel	QSCMLXPL4224NC	403	42	24	1
	QSCMLXPL4230NC	472	42	30	1
	QSCMLXPL4236NC	543	42	36	1
	QSCMLXPL4242NC	684	42	42	1
	QSCMLXPL4248NC	703	42	48	1
	QSCMLXPL4824NC	415	48	24	1
	QSCMLXPL4830NC	488	48	30	1
	QSCMLXPL4836NC	558	48	36	1
	QSCMLXPL4842NC	703	48	42	1
	QSCMLXPL4848NC	725	48	48	1
	QSCMLXPL5424NC	444	54	24	1
	QSCMLXPL5430NC	521	54	30	1
	QSCMLXPL5436NC	598	54	36	1
	QSCMLXPL5442NC	676	54	42	1
	QSCMLXPL5448NC	830	54	48	1

CMLXPLXXXNC • EXTENSION END OF RUN, RIGHT, NO CONNECTION

- Provides floor standing support while enclosing the end of a gallery panel run.
- Attached at the end of a gallery panel to extend the gallery panel run.
- Connections only at one exposed end.
- Includes all attachment hardware and glides.
- Total height is inclusive of panel glides extended to their full height.
- Please specify LP laminate finish and PVC edge finish.
- If a wood grain laminate is chosen, grain direction run horizontally.
- Gallery panel is edged in PVC on exposed edges and self edged on edge connecting to panel.

DESCRIPTION	PRODUCT CODE	LIST PRICE	DIMENSIONS/INCHES		
			H	W	D
 Extension End of Run Gallery Panel	QSCMLXPR4224NC	403	42	24	1
	QSCMLXPR4230NC	472	42	30	1
	QSCMLXPR4236NC	543	42	36	1
	QSCMLXPR4242NC	684	42	42	1
	QSCMLXPR4248NC	703	42	48	1
	QSCMLXPR4824NC	415	48	24	1
	QSCMLXPR4830NC	488	48	30	1
	QSCMLXPR4836NC	558	48	36	1
	QSCMLXPR4842NC	703	48	42	1
	QSCMLXPR4848NC	725	48	48	1
	QSCMLXPR5424NC	444	54	24	1
	QSCMLXPR5430NC	521	54	30	1
	QSCMLXPR5436NC	598	54	36	1
	QSCMLXPR5442NC	676	54	42	1
	QSCMLXPR5448NC	830	54	48	1

CMHLPBB01 - LAMINATE PANEL BRACKET

- Laminate panel bottom bracket connects two gallery end panels at bottom with screws.
- Available in standard paint colors.
- Screws are included with the bracket.

DESCRIPTION	PRODUCT CODE	LIST PRICE	DIMENSIONS/INCHES		
			H	W	D

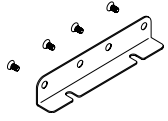

Bracket	QSCMHL PBB01	46	1.5	8	1
---------	--------------	----	-----	---	---

CMHLPCB01 - LAMINATE PANEL CORNER BRACKET

- Gallery panel corner bottom bracket connects two laminate panels at 90 degrees.
- Available in standard paint colors.
- Screws are included with the bracket.

DESCRIPTION	PRODUCT CODE	LIST PRICE	DIMENSIONS/INCHES		
			H	W	D

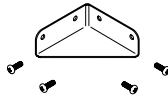



Corner Bracket	QSCMHL PCB01	44	1.5	4	4
----------------	--------------	----	-----	---	---



CHP POST PACKAGE

- Universal Post with all "Quick-Connection" clips.
- Post trim(s)
- Post base and top cap

	DESCRIPTION	PRODUCT CODE	LIST PRICE	DIMENSIONS/INCHES		
				H	W	D
	2 - Way Post	QSCHP42-2	115	42	2.3	2.3
		QSCHP54-2	142	54	2.3	2.3
		QSCHP66-2	167	66	2.3	2.3
	3 - Way Post	QSCHP42-3	101	42	2.3	2.3
		QSCHP54-3	126	54	2.3	2.3
		QSCHP66-3	151	66	2.3	2.3
	4 - Way Post *No trim or base. Includes top cap only.	QSCHP42-4	82	42	2.3	2.3
		QSCHP54-4	106	54	2.3	2.3
		QSCHP66-4	126	66	2.3	2.3

CHPXW - 90 DEGREE CORNER POST KIT FOR OVER PANELS

- Specify the corner post height that matches the height of the over panel
- 2-way kits include 2 trims (CMETPxx), 2 way post base (CMPCxx) and post cap (CMPC).
- 3-way kits include 2 trim (CMETPxx), 3 way post base (CMPCxx) and post cap (CMPC).
- 4-way kits include post cap (CMPC) only.

	DESCRIPTION	PRODUCT CODE	LIST PRICE	DIMENSIONS/INCHES		
				H	W	D
	90 Degree Corner Post Kit for Over Panels	QSCHOP12-2	75	12	2.3	2.3
		QSCHOP12-3	64	12	2.3	2.3
		QSCHOP12-4	44	12	2.3	2.3
		QSCHOP24-2	84	24	2.3	2.3
		QSCHOP24-3	75	24	2.3	2.3
		QSCHOP24-4	63	24	2.3	2.3

CMET - END OF RUN TRIM INSERT FOR PANEL

- Trim inserts are not included with panels.
- Cannot be used for a universal post application.
- Used at the end of each panel run and cannot be used to attach a panel run to a fixed wall.
- Vertical trims must be specified separately. Trim snaps in the panel at the end of run.
- Standard Compile paint options.
- See Panel Configuration Tips for application.
- Trims are PVC.

DESCRIPTION	PRODUCT CODE	LIST PRICE	DIMENSIONS/INCHES		
			H	W	D



End of Run Trim Insert for Panel	QSCMET42	21	42	2.3	0.5
	QSCMET54	25	54	2.3	0.5
	QSCMET66	27	66	2.3	0.5

CMET - TRIM INSERT FOR STEP DOWN

- Does not come with a post. Trim inserts are not included with Universal Corner Posts.
- Specify to meet the taller post.
- Trim snaps in the post or end of run at a change in height.
- Available in standard Compile paint options.
- Can not be applied to 60 degree posts.
- See Panel Configuration Tips for application.

DESCRIPTION	PRODUCT CODE	LIST PRICE	DIMENSIONS/INCHES		
			H	W	D



Trim Insert for Step Down	QSCMET12	14	12	2.3	
	QSCMET24	24	24	2.3	



CMRCXXNP - COMPILE RACEWAY COVER - WITHOUT KNOCKOUTS

- No electrical knockouts included.
- Note: Made of reinforced aluminum.

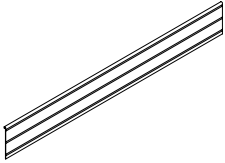
	DESCRIPTION	PRODUCT CODE	LIST PRICE	DIMENSIONS/INCHES		
				H	W	D
	Compile Raceway Cover Without Knockouts	QSCMRC24NP	18	5	24	
		QSCMRC30NP	22	5	30	
		QSCMRC36NP	25	5	36	
		QSCMRC42NP	27	5	42	
		QSCMRC48NP	30	5	48	
		QSCMRC54NP	37	5	54	
		QSCMRC60NP	39	5	60	
		QSCMRC60NP	39	5	60	

CMRCXXPO - COMPILE RACEWAY COVER - WITH KNOCKOUTS

- Contains one knockout for 24" w and three knockouts for 30" w+.
- Raceway Knockout Cover must be added to openings where duplex receptacles are not used.
- Note: Made of reinforced aluminum.

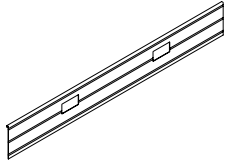
	DESCRIPTION	PRODUCT CODE	LIST PRICE	DIMENSIONS/INCHES		
				H	W	D
	Compile Raceway Cover With Knockouts	QSCMRC24PO	18	5	24	
		QSCMRC30PO	22	5	30	
		QSCMRC36PO	25	5	36	
		QSCMRC42PO	27	5	42	
		QSCMRC48PO	30	5	48	
		QSCMRC54PO	37	5	54	
		QSCMRC60PO	39	5	60	
		QSCMRC60PO	39	5	60	

CMRCB01 - COMPILE RACEWAY KNOCKOUT COVER

- Fills knockout when duplex is not used.
- Available in Black, White, Nevada and Fog.
- Note: Knockout covers are made of plastic.

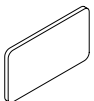
	DESCRIPTION	PRODUCT CODE	LIST PRICE	DIMENSIONS/INCHES		
				H	W	D
	Compile Raceway Knockout Cover	QSCMRCB01	17	1.5	2.756	

CHWAXX - WALL ADAPTER

- Same profile as vertical extrusion.
- Wall attachment hardware not provided.
- Made of aluminum.

	DESCRIPTION	PRODUCT CODE	LIST PRICE	DIMENSIONS/INCHES		
				H	W	D
	Wall Adapter	QSCHWA42	64	42	2.36	.79
		QSCHWA54	81	54	2.36	.79
		QSCHWA66	94	66	2.36	.79

CWMA - VERTICAL CHANNEL

- Used to attach system components to fixed wall.
- Panel frame finish.
- Comes in 60" length only.
- Care should be taken to mount adapters only to wall studs using correct fasteners.
- Does not include mounting hardware. Mounting hardware selection to be based on wall material. Sold in pairs.
- Failure to do this may result in collapse of the unit and subsequent possible personal injury.
- Compile vertical channels cannot be shared.

	DESCRIPTION	PRODUCT CODE	LIST PRICE	DIMENSIONS/INCHES		
				H	W	D
	Vertical Channel	QSCWMA60	39	60	0.6	0.7



CMPC - UNIVERSAL POST CAP

- Comes standard with universal post.
- Specified separately for reconfiguration purposes.
- Available in standard Compile paint options.
- Made of PVC.

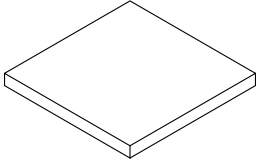
	DESCRIPTION	PRODUCT CODE	LIST PRICE	DIMENSIONS/INCHES		
				H	W	D
	Universal Post Cap	QSCMPC	8	.7	2.5	2.5

CMPC - POST BASE COVER

- Post Base Covers are not included with Universal Corner Posts.
- Base trim for universal post. These are connected with screws at the base and the trims at the post will slide to meet.
- Available for 2-way and 3-way configurations.
- Finish is smooth plastic.
- Available in standard Compile paint options.

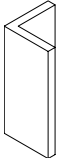
	DESCRIPTION	PRODUCT CODE	LIST PRICE	DIMENSIONS/INCHES		
				H	W	D
	Post Base Cover - 3-Way Connection	QSCMPC1	13	5	2.3	.033
	Post Base Cover - 2-Way Connection	QSCMPC2	14	5	2.3	2.31

CMPS - POST SEPARATOR

- Creates a diagonal division within a compile post.
- Please specify post height.

	DESCRIPTION	PRODUCT CODE	LIST PRICE	DIMENSIONS/INCHES		
				H	W	D
	Post Separator	QSCMPS01	154	96	3.25	14 gauge-