

storage

**LATERAL FILE FEATURES**

## DRAWERS/SHELVES

- Drawer interlocking system
- Three-stage, anti-bounceback suspension
- Pre-installed, side-to-side file bars for letter, legal and A4
- Front-to-back file bars – optional
- Full-height dividers – optional
- Angled full pull

## CONSTRUCTION

- Top stiffener bar
- Corner gussets
- Four (4) ganging drill points are marked to ensure correct positioning
- Cam lock included
- Leveling glides
- Counterweights are included in 2, 3 and 4 drawer cabinets. BIFMA does not require counterweight in 5 drawer cabinets.

**PEDESTAL FEATURES**

## DRAWERS/SHELVES

- All drawer fronts feature a recessed, angled full pull.
- Drawers feature ball bearing suspension.

## CONSTRUCTION

- Central Core removable cam locks.
- Pedestals are 15" wide.
- Counterweight is standard on all Freestanding models.
- Worksurfaces supporting models have holes drilled in top to attach underneath a worksurface.

**STANDARD PAINT COLORS**

BLACK	BLK
DESIGNER WHITE	DWT
NEVADA	NEV
STEEL	STL

**TEXTURED PAINT COLORS**

Only available on Compile Storage.

BLIZZARD	BZD
STONE DUST	SDT

**GENERAL WARRANTY INFORMATION**

- Evolve warrants all components of metal storage and filing for the lifetime of the product to the original purchaser.

This page provides a three dimensional view of a sample configuration highlighting each storage component required when specifying this configuration.

## Components

- A. CSOF13XX KD Overhead
- B. CSSL13XX Low-Profile Shelf
- C. CM19XXBBF Worksurface Supporting Box, Box, File Pedestal

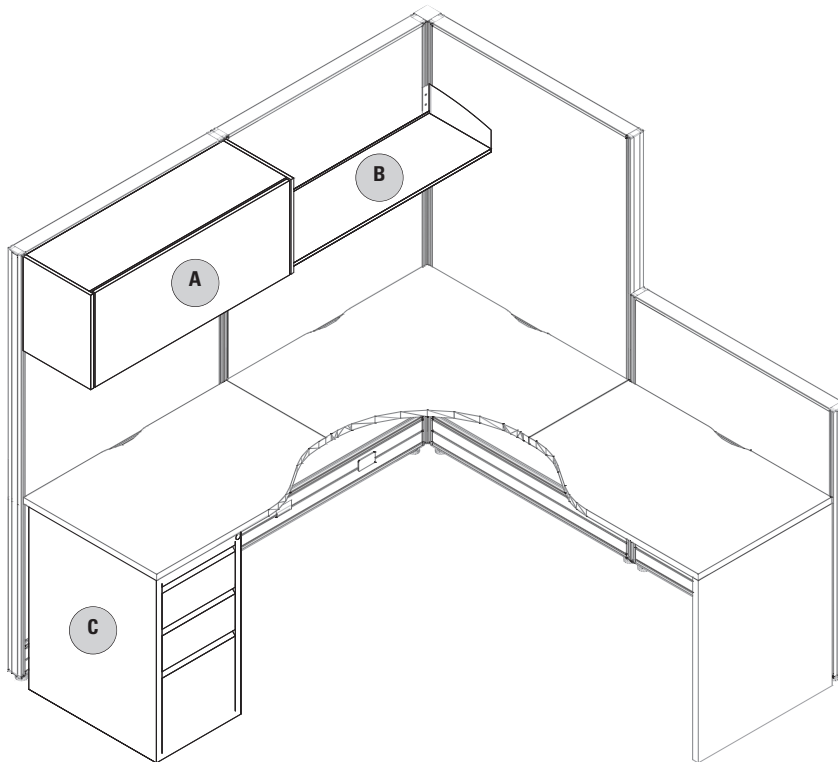

# STORAGE

## CS19XXBBF - WORKSURFACE SUPPORTING BOX/BOX/FILE 15" PEDESTAL

- Worksurface supporting, with predrilled holes in the top.
- Also available as freestanding with finished top.
- All drawer fronts feature a recessed, angled full pull.
- Pedestal height shown includes glide.
- Pencil tray and Lock included.
- File Bars are not included with Compile pedestals. To order file bars, use product code CSPEDHFB at \$15.00 each list.

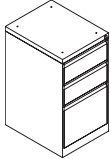
	DESCRIPTION	PRODUCT CODE	LIST PRICE	DIMENSIONS/INCHES		
				H	D	W
	Worksurface Supporting Box/Box/File 15" Pedestal	CS1919BBF	347	27 5/8	18 5/8	15
		CS1923BBF	357	27 5/8	22 5/8	15
		CS1929BBF	405	27 5/8	29 5/8	15

## CS19XXFF - WORKSURFACE SUPPORTING FILE/FILE 15" PEDESTAL

- Worksurface supporting, with predrilled holes in the top.
- Also available as freestanding with finished top.
- All drawer fronts feature a recessed, angled full pull.
- Pedestal height shown includes glide.
- Lock included.
- File Bars are not included with Compile pedestals. To order file bars, use product code CSPEDHFB at \$15.00 each list.

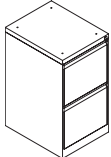
	DESCRIPTION	PRODUCT CODE	LIST PRICE	DIMENSIONS/INCHES		
				H	D	W
	Worksurface Supporting File/File 15" Pedestal	CS1919FF	347	27 5/8	18 5/8	15
		CS1923FF	357	27 5/8	22 5/8	15
		CS1929FF	405	27 5/8	29 5/8	15

## CS19FXXBBF - FREESTANDING BOX/BOX/FILE 15" PEDESTAL

- All drawer fronts feature a recessed, angled full pull.
- Pedestal height shown includes glide.
- Finished top.
- Counterweight, Pencil tray and Lock included.
- File Bars are not included with Compile pedestals. To order file bars, use product code CSPEDHFB at \$15.00 each list.

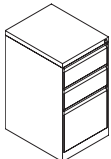
	DESCRIPTION	PRODUCT CODE	LIST PRICE	DIMENSIONS/INCHES		
				H	D	W
	Freestanding Box/Box/File 15" Pedestal	CS19F19BBF	357	27 5/8	18 5/8	15
		CS19F23BBF	368	27 5/8	22 5/8	15
		CS19F29BBF	415	27 5/8	29 5/8	15

## CS19FXXFF - FREESTANDING FILE/FILE 15" PEDESTAL

- All drawer fronts feature a recessed, angled full pull.
- Pedestal height shown includes glide.
- Finished top.
- Counterweight and Lock included.
- File Bars are not included with Compile pedestals. To order file bars, use product code CSPEDHFB at \$15.00 each list.

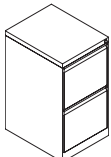
	DESCRIPTION	PRODUCT CODE	LIST PRICE	DIMENSIONS/INCHES		
				H	D	W
	Freestanding File/File 15" Pedestal	CS19F19FF	357	27 5/8	18 5/8	15
		CS19F23FF	368	27 5/8	22 5/8	15
		CS19F29FF	415	27 5/8	29 5/8	15



# STORAGE

## CS19MPXXBBF - MOBILE BOX/BOX/FILE PEDESTAL

- All drawer fronts feature a recessed, angled full pull.
- Pedestal height shown includes glide.
- Finished top.
- Counterweight, Pencil tray, and Lock included.
- File Bars are not included with Compile pedestals. To order file bars, use product code CSPEDHFB at \$15.00 each list.

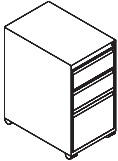
	DESCRIPTION	PRODUCT CODE	LIST PRICE	DIMENSIONS/INCHES		
				H	D	W
	Mobile Box/Box/File Pedestal	CS19MP19BBF	473	27 5/8	18 5/8	15
		CS19MP23BBF	499	27 5/8	22 5/8	15

## CS19MPXXFF - MOBILE FILE/FILE PEDESTAL

- All drawer fronts feature a recessed, angled full pull.
- Pedestal height shown includes glide.
- Finished top.
- Counterweight and Lock included.
- File Bars are not included with Compile pedestals. To order file bars, use product code CSPEDHFB at \$15.00 each list.

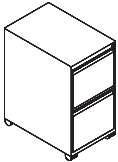
	DESCRIPTION	PRODUCT CODE	LIST PRICE	DIMENSIONS/INCHES		
				H	D	W
	Mobile File/File Pedestal	CS19MP19FF	473	27 5/8	18 5/8	15
		CS19MP23FF	499	27 5/8	22 5/8	15

## CSMCPXXBFNC - MOBILE BOX/FILE PEDESTAL WITH 60MM CASTERS

- Mobile pedestal that includes one pencil tray and one divider.
- Includes factory installed counterweight.
- Lock is standard.
- 60mm high casters.
- For use with pedestal seat cushion. See model below.
- Casters do not lock.

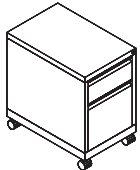
	DESCRIPTION	PRODUCT CODE	LIST PRICE	DIMENSIONS/INCHES		
				H	D	W
	Mobile Box/File Pedestal with 60mm Casters	CSMCP19BFNC	515	23.875	18.625	15
		CSMCP23BFNC	525	23.875	22.625	15

# STORAGE

## CSCUSH15 - PEDESTAL SEAT CUSHIONS

- Cushions will have single stitching at the seams.
- Velcro included for quick attachment to pedestal file.
- 1" Cushion will have a rectilinear design on all sides.
- 2" Cushion will have waterfall edges Front and Back,
- Cushions are for use on CSMCPXXBFNC Mobile Pedestals.
- Please choose a fabric from the standard cushion textiles on pages 94-96

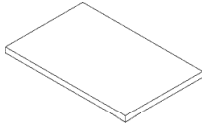
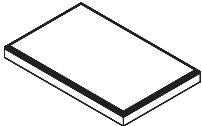
	DESCRIPTION	PRODUCT CODE	LIST PRICE/GRADES														DIM./INCH			YRDS			
			1	2	3	4	5	6	7	8	9	10	11	12	13	14	15	16	17		H	D	W
	Pedestal Seat	CSCUSH15X18-5/8x1	141	165	183	210	249	267	302	358	401	449	547	652	636	724	901	1077	1254	1	18.625	15	1
	Cushions - 1" Thick	CSCUSH15X22-5/8x1	159	183	201	228	267	285	320	376	419	467	565	670	651	739	916	1092	1269	1	22.625	15	1
	Pedestal Seat	CSCUSH15X18-5/8x2	157	180	198	225	264	282	317	373	416	464	561	668	820	938	1173	1408	1644	2	18.625	15	2
	Cushions - 2" Thick	CSCUSH15X22-5/8x2	176	200	222	257	307	330	375	447	502	563	689	824	729	828	1026	1225	1424	2	22.625	15	2

## CSSL13 - LOW PROFILE SHELF

- 13" deep panel-mounted storage shelf with backlip.
- Mounting brackets are included.

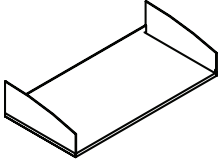
	DESCRIPTION	PRODUCT CODE	LIST PRICE	DIMENSIONS/INCHES		
				H	D	W
	Low Profile Shelf - 13"	CSSL1324	84	5	13	24
		CSSL1330	94	5	13	30
		CSSL1336	101	5	13	36
		CSSL1342	110	5	13	42
		CSSL1348	115	5	13	48
		CSSL1354	120	5	13	54
		CSSL1360	125	5	13	60

## CSOF13 - KD OVERHEAD

- Mounting brackets are included.
- Door retracts up and over the cabinet
- Ready for quick assembly on site.
- Quality steel construction.
- 60" unit is reinforced for proper weight distribution.
- Inside dimensions: 12" h x 12.75" d
- Lock sold separately, see model CMSLK13 - list price \$25 each.

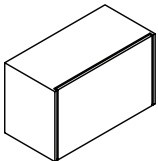
	DESCRIPTION	PRODUCT CODE	LIST PRICE	DIMENSIONS/INCHES		
				H	D	W
	KD Overhead - 13"	CSOF1324	225	14.5	13	24
		CSOF1330	247	14.5	13	30
		CSOF1336	273	14.5	13	36
		CSOF1342	289	14.5	13	42
		CSOF1348	305	14.5	13	48
		CSOF1354	345	14.5	13	54
		CSOF1360	373	14.5	13	60



# STORAGE

## CMDA0HXX - CENTER MOUNT OVERHEAD

- Inside dimensions 13" high x 13" deep.
- Laminate Overhead. No doors.
- Available in standard Compile laminate finishes.
- Top mount on panels.
- Overhead Support Brackets are included.

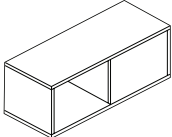
	DESCRIPTION	PRODUCT CODE	LIST PRICE	DIMENSIONS/INCHES		
				H	D	W
	Center Mount Overhead - 13"	CMDA0H36	744	15	13	36
		CMDA0H42	808	15	13	42
		CMDA0H48	845	15	13	48
		CMDA0H54	909	15	13	54
		CMDA0H60	945	15	13	60

## CMSLK13 - LOCK FOR KD OVERHEAD

- Must be specified seperately.

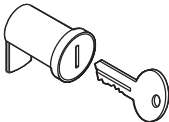
	DESCRIPTION	PRODUCT CODE	LIST PRICE	DIMENSIONS/INCHES		
				H	D	W
	Lock for KD Overhead	CMSLK13	27			

## CMS\_\_ - ADDITIONAL KEY

	DESCRIPTION	PRODUCT CODE	LIST PRICE	DIMENSIONS/INCHES		
				H	D	W
	LOCKKEY - Core and Key	CSLOCKKEY	25			

## CMADAXPM - ADA COMPLIANT OVERHEAD STORAGE UNIT

- Panel Mounted Overhead Storage with metal sides and opaque door that retracts on top of the unit
- Meets CSA B651 Barrier Free Design & ADA (American Disabilities Act).
- 16" high units accept standard and A4 binders.
- All shelves are reinforced for proper weight distribution.
- Inside dimensions: 14.25" high x 12" deep.
- Unit includes attachment hardware, lock and mounting brackets. Back not included.
- Shipped partially assembled.
- Available in standard Compile paint colors only. Door made of opaque plastic. \*\*add 10% upcharge for Tungsten

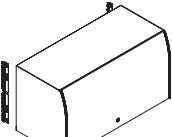
	DESCRIPTION	PRODUCT CODE	LIST PRICE	DIMENSIONS/INCHES		
				H	D	W
	ADA Compliant Overhead Storage Unit	CMADA30PM	757	16	14.2	30
		CMADA36PM	817	16	14.2	36
		CMADA42PM	873	16	14.2	42
		CMADA48PM	932	16	14.2	48
		CMADA54PM	990	16	14.2	54
		CMADA60PM	1047	16	14.2	60

# STORAGE

## CS19XX-1X1FH - ONE 1/2 HEIGHT FIXED FRONT & ONE 12" FIXED FRONT LATERAL FILE

- 1/2 Height Box Drawer.
- 1 Fixed Drawer Front.
- Includes Lock.
- Lateral File Top is required when not installed under a worksurface.
- Counterweights must be specified on lateral files with pull out drawers, unless worksurface supporting, ganged together or anchored to the floor or wall.

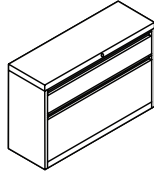
	DESCRIPTION	PRODUCT CODE	LIST PRICE	DIMENSIONS/INCHES		
				H	D	W
	One 1/2 Height Fixed Front &	CS1930P-1x1FH	788	21.75	19.25	30
	One 12" Fixed Front Lateral File	CS1936P-1x1FH	840	21.75	19.25	36
		CS1942P-1x1FH	893	21.75	19.25	42

## CS19XX-1XSND - ONE 1/2 HEIGHT OPEN SHELF & ONE 12" OPEN SHELF LATERAL CABINET

- 1/2 Height Open Shelf.
- Bottom Open Shelf.

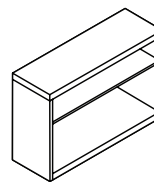
	DESCRIPTION	PRODUCT CODE	LIST PRICE	DIMENSIONS/INCHES		
				H	D	W
	One 1/2 Height Open Shelf &	CS1930-1xSND	394	21.75	19.25	30
	One 12" Open Shelf Lateral Cabinet	CS1936-1xSND	447	21.75	19.25	36
		CS1942-1xSND	499	21.75	19.25	42

## CSCUSH19 - LATERAL SEAT CUSHIONS

- Cushions will have single stitching at the seams,
- Velcro included for quick attachment to lateral file.
- 1" Cushion will have a rectilinear design on all sides.
- 2" Cushion will have waterfall edges Front and Back.
- Please choose a fabric from the standard cushion textiles on pages 244-246.

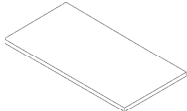
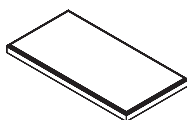
	DESCRIPTION	PRODUCT CODE	LIST PRICE/GRADES														DIM./INCH			YRDS			
			1	2	3	4	5	6	7	8	9	10	11	12	13	14	15	16	17		H	D	W
	Lateral Seat	CSCUSH19-25X30X1	261	292	316	352	405	430	477	553	611	676	808	950	982	1106	1352	1599	1847	1	19	30	1
	Cushions - 1" Thick	CSCUSH19-25X36X1	270	300	325	362	414	438	486	561	620	684	817	958	1136	1221	1503	1783	2064	1	19	36	1
		CSCUSH19-25X42X1	280	310	335	371	423	448	496	571	629	694	826	968	1143	1230	1511	1791	2072	1	19	42	1
	Lateral Seat	CSCUSH19-25X30X2	290	321	345	381	434	458	505	580	639	703	836	978	1154	1239	1520	1801	2082	2	19	30	2
	Cushions - 2" Thick	CSCUSH19-25X36X2	298	329	353	390	441	467	514	589	647	712	844	986	1173	1258	1538	1819	2100	2	19	36	2
		CSCUSH19-25X42X2	308	339	363	400	452	476	523	599	657	721	854	996	1183	1267	1548	1829	2109	2	18	42	2





# STORAGE

## CWFT - LATERAL FILE TOPS

- Available in standard Compile finishes.

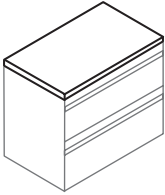
	DESCRIPTION	PRODUCT CODE	LIST PRICE LP	DIMENSIONS/INCHES		
				H	D	W
	Lateral File Tops	CWFT1930	117	1	19.25	30
		CWFT1936	120	1	19.25	36
		CWFT1942	154	1	19.25	42
	2 Lateral Files SBS Top	CWFT1960	244	1	19.25	60
		CWFT1972	266	1	19.25	72
		CWFT1984	433	1	19.25	84
	4 Lateral File BTB Top	CWFT3860	487	1	38.75	60
		CWFT3872	555	1	38.75	72
		CWFT3884	658	1	38.75	84

## CS19XXP - 2F12 - LATERAL FILES - 2 DRAWERS WITH COUNTERWEIGHT

- Counterweight is standard. Two fixed front drawers.
- Side-to-side hanging file bars included.
- Drawers are 12.25" high.
- File cannot be used to store standard three ring binders.
- Lock included.

	DESCRIPTION	PRODUCT CODE	LIST PRICE	DIMENSIONS/INCHES		
				H	D	W
	Lateral Files - 2 Drawers with Counterweight	CS1930P-2F12	625	27.14	19.25	30
		CS1936P-2F12	672	27.14	19.25	36
		CS1942P-2F12	699	27.14	19.25	42

## CS19XXP - 3F12 - LATERAL FILES - 3 DRAWERS WITH COUNTERWEIGHT

- Counterweight is standard. Three fixed front drawers.
- Side-to-side hanging file bars included.
- Drawers are 12.25" high.
- File cannot be used to store standard three ring binders.
- Lock included.

	DESCRIPTION	PRODUCT CODE	LIST PRICE	DIMENSIONS/INCHES		
				H	D	W
	Lateral Files - 3 Drawers with Counterweight	CS1930P-3F12	777	39.52	19.25	30
		CS1936P-3F12	819	39.52	19.25	36
		CS1942P-3F12	856	39.52	19.25	42

# STORAGE

## CS19XXP - 4F12 - LATERAL FILES - 4 DRAWERS WITH COUNTERWEIGHT

- Counterweight is standard. Four fixed front drawers.
- Side-to-side hanging file bars included.
- Drawers are 12.25" high.
- File cannot be used to store standard three ring binders.
- Posting shelf option NOT available.
- Lock included.

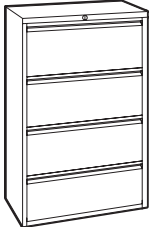
	DESCRIPTION	PRODUCT CODE	LIST PRICE	DIMENSIONS/INCHES		
				H	D	W
	Lateral Files - 4 Drawers with Counterweight	CS1930P-4F12	993	51.89	19.25	30
		CS1936P-4F12	1040	51.89	19.25	36
		CS1942P-4F12	1119	51.89	19.25	42

## CS19XXP - 5F12 - LATERAL FILES - 5 DRAWERS

- Four fixed front drawers plus top drawer with receding door and roll-out shelf.
- Side-to-side hanging file bars included.
- Drawers are 12.25" high.
- File cannot be used to store standard three ring binders.
- Posting shelf option NOT available.
- Lock included.

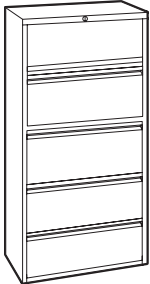
	DESCRIPTION	PRODUCT CODE	LIST PRICE	DIMENSIONS/INCHES		
				H	D	W
	Lateral Files - 5 Drawers	CS1930P-5F12	1182	66.39	19.25	30
		CS1936P-5F12	1234	66.39	19.25	36
		CS1942P-5F12	1302	66.39	19.25	42



SO# \_\_\_\_\_ PO# \_\_\_\_\_ TAG# \_\_\_\_\_ Date \_\_\_\_\_

KEY#	SETS REQ'D	KEY#	SETS REQ'D	KEY#	SETS REQ'D	KEY#	SETS REQ'D	KEY#	SETS REQ'D
401		431		461		491		521	
402		432		462		492		522	
403		433		463		493		523	
404		434		464		494		524	
405		435		465		495		525	
406		436		466		496		526	
407		437		467		497		527	
408		438		468		498		528	
409		439		469		499		529	
410		440		470		500		530	
411		441		471		501		531	
412		442		472		502		532	
413		443		473		503		533	
414		444		474		504		534	
415		445		475		505		535	
416		446		476		506		536	
417		447		477		507		537	
418		448		478		508		538	
419		449		479		509		539	
420		450		480		510		540	
421		451		481		511		541	
422		452		482		512		542	
423		453		483		513		543	
424		454		484		514		544	
425		455		485		515		545	
426		456		486		516		546	
427		457		487		517		547	
428		458		488		518		548	
429		459		489		519		549	
430		460		490		520		550	

401-430 =	431-460 =	461-490 =	491-520 =	521-550 =
-----------	-----------	-----------	-----------	-----------

Total:

NOTE : If Key Alike Instructions are not submitted to EVOLVE with the Customer's Purchase Order, all components will be keyed randomly.